

# Gutta Percha Obturation Device Instruction Manual

CE 0197

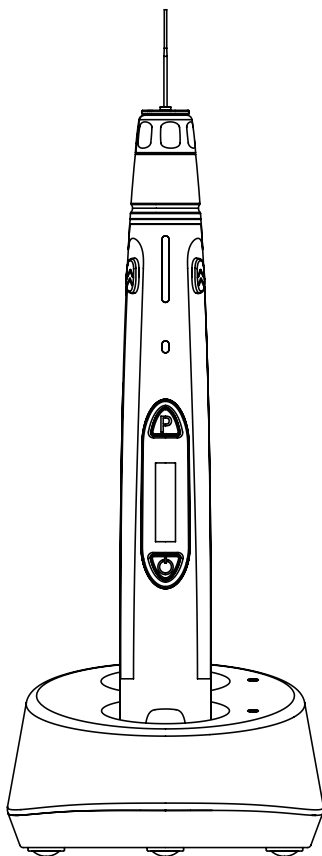

**Fi-E**

**Guilin Woodpecker Medical Instrument Co., Ltd.**

# Contents

<b>Introduction</b>	<b>1</b>
<b>1 Product introduction</b>	<b>1</b>
<b>2 European authorized representative</b>	<b>6</b>
<b>3 Standard icons</b>	<b>7</b>
<b>4 Contraindications</b>	<b>7</b>
<b>5 Installation and disassembly method of accessories</b>	<b>7</b>
<b>6 Operation method</b>	<b>8</b>
<b>7 Charging instruction</b>	<b>11</b>
<b>8 Safety precautions</b>	<b>11</b>
<b>9 Cleaning,Disinfection,Sterilization and Maintenance</b>	<b>12</b>
<b>10 Troubleshooting</b>	<b>17</b>
<b>11 After-sales service</b>	<b>18</b>
<b>12 Environment protection</b>	<b>18</b>
<b>13 EMC-Declaration of conformity</b>	<b>19</b>
<b>14 Statement</b>	<b>22</b>

## Introduction

Thank you for purchase Fi-E Hot Melting and Filling Instrument developed by Guilin Woodpecker Medical Instrument Co., Ltd, a Hi-tech enterprise developing, manufacturing, and selling dental instruments. Woodpecker has excellent Quality Control System. To guarantee correct and safe operation, please read this Instruction Manual carefully before use. Depending on the level of risk involved, safety requirements are classed under the following indications:



**Danger: (always referred to personal injury)**



**warning: (referred to possible damage to property)**

## 1 Product introduction

### 1.1 Intended use

Heat up and soften gutta-percha, and fill the gutta-percha into the root canal after preparation. And the applied part is Gutta Percha Injecting Needle.

### 1.2 Diagram of components and control buttons

The Fi-E is equipped with symmetrical operation buttons, which can be suitable for left-handed or right-handed operation. The button position is at the position of the thumb and index finger when the doctor is holding it, making the operation more portable.

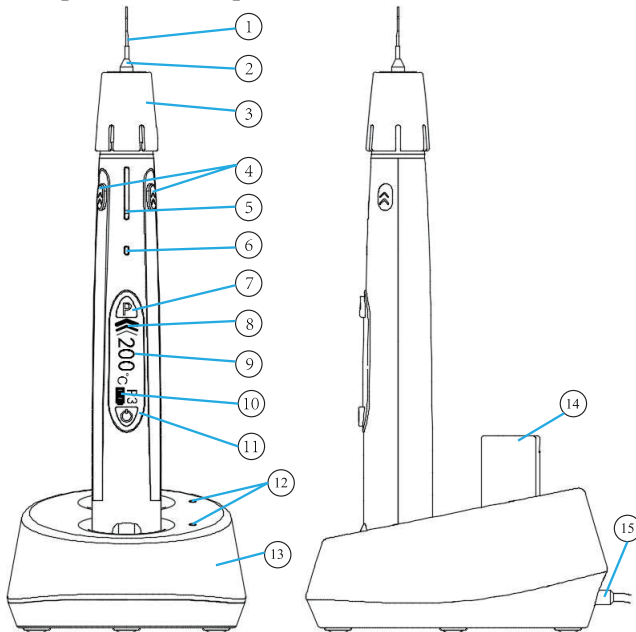

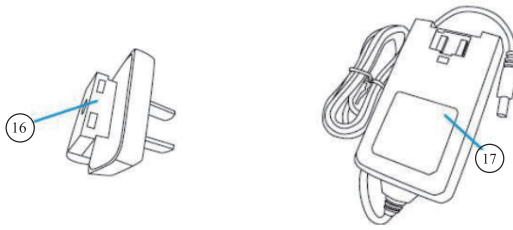

- |  |                           |
|--|---------------------------|
| 1. Gutta Percha Injecting Needle           |                           |
| 2. Gutta Percha Injecting Needle Protector |                           |
| 3. Thermal Protector Cap                   | 4. Injecting button       |
| 5. Gutta-percha amount level               | 6. Heating indicator      |
| 7. Mode button                             | 8. Injecting speed        |
| 9. Preset temperature Level                | 10. Battery level         |
| 11. “ON/OFF” button                        | 12. Charging indicator    |
| 13. Charging base                          | 14. Spare lithium battery |
| 15. Connecting hole for power supply       |                           |
| 16. Power adapter plug                     | 17. Power adapter unit    |

1) “ON/OFF” button:

a) In the OFF state, long press the “ON/OFF” button can turn on the power. After the power is turned on, the displays will be lit at the same time.

b) In the ON state, long press the “ON/OFF” button can turn off the power.

2) Battery level

The actual power of the battery is displayed in real time on the screen. When the battery is fully charged, the power of the OLED display is displayed as five grids. When the battery level is one grid, it indicates that the battery is low and needs to be charged in time. When the battery level is displayed as a space, it indicates that the battery is very low and needs to be charged immediately.

Note: During normal use, try not to let the battery level reduced to space status (completely no power) before charge, which will shorten the service life of battery.

**⚠ Warning:**

**If the device has not been used for more than one month, the battery needs to be recharged. If the device is not in use for a long time, please be sure to charge it at least once a month to protect the battery. If the device is not in use for a long time, please remove the battery. The service life of battery of Hot Melting and Filling Instrument will be shortened when it is in a low battery state for a long time or when it leaves the charging base for a long time.**

3) Temperature Level

When the temperature is preset, the display screen shows the preset temperature value.

4) Charging base

Firstly, connect the power adapter plug to the power adapter as shown in Figure 2.

Then connect the power adapter to the charging base as shown in Figure 3 and connect the power adapter to a standard socket. Place the Hot Melting and Filling Instrument correctly on the charging base as shown in Figure 4, so that the charging connector under the Hot Melting and Filling Instrument can be reliably connected to the output connector of the charging base. When the Hot Melting and Filling Instrument is properly connected to the charging base, the LED charging indicator on the base will be on constantly. If the LED is flashing or not lit, please check all the cables carefully.

There are charging status indicators on the charging base. When the Hot Melting and Filling Instrument is not placed on the charging base, the indicator will flashes in amber and green alternately. When the Hot Melting and Filling Instrument is placed on the charging base, if the charging is being charged, the amber indicator will be on constantly. When the battery is full, the amber indicator will be off and the green indicator will be on constantly.

**Notes: After receiving the device, please charge it immediately. Before use, please be sure that battery is fully charged. When the device is fully charged, the battery level of the Hot Melting and Filling Instrument led display screen is the highest. After the battery runs out, the time of battery charging takes at least 2 hours and 30 minutes.**

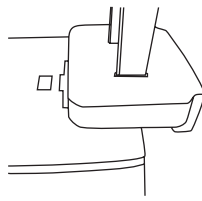

Figure 2 Installation of power adapter

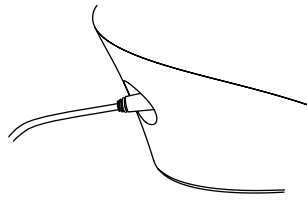

Figure 3 Connection to power supply

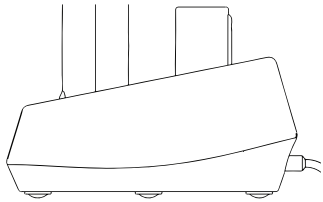
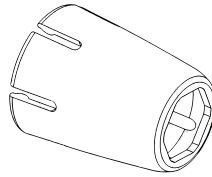

Figure 4 Charging

### 5) Thermal Protector Cap

The design of Thermal Protector Cap is to protect the oral soft tissue and lip from scalding.



**Note: Before use, please clean, disinfect and sterilize the Thermal Protector Cap.**

### 6) Gutta Percha Injecting Needle

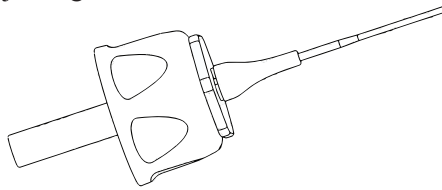

**Note:**

- 1. Store unused Gutta Percha Injecting Needles in a sealed environment, as the Gutta Percha Injecting Needle are made of silver and may discolor due to oxidation caused by long-term exposure to air.**
- 2. Please use the wrench provided by the company to connect, disassemble and pre-bend the Gutta Percha Injecting Needle.**

### 7) Wrench

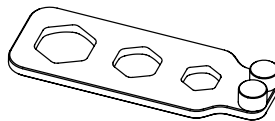

The wrench is used to tighten the Gutta Percha Injecting Needle and its connection to Hot Melting and Filling Instrument. After tighten the Gutta Percha Injecting Needle, the needle can be bent to any suitable angle with wrench.

After pre-bending the silver needle, you can also put the hexagonal hole on the wrench over the hexagonal sheet of the Gutta Percha Injecting Needle, and rotate the silver needle to the desired position.

Do not use other instruments to pre-bend the needle other than the wrench provided by manufacturers.

## **1.3 Device includes**

1. Hot Melting and Filling Instrument
2. Charging base
3. Power adapter with cord
4. Gutta Percha Injecting Needles
5. Thermal Protector Cap
6. Gutta Percha Injecting Needle Protector

- 7.Wrench
- 8.Instruction Manual
- 9.Qualified Certification
- 10.Warranty card
- 11.Packing list

Model	Gauge	Length	Remark
E20G-S	20Ga	22mm	Reusable
E20G-M	20Ga	24mm	Reusable
E20G-L	20Ga	28mm	Reusable
E23G-M	23Ga	24mm	Reusable
E23G-L	23Ga	28mm	Reusable
E25G-M	25Ga	24mm	Reusable
E25G-L	25Ga	28mm	Reusable
E20G-NR	20Ga	28mm	Single use
E23G-NR	23Ga	28mm	Single use
E25G-NR	25Ga	28mm	Single use

Table 2 Models of Gutta Percha Injecting Needles

**1.4 Introduction and scope of application**

1.4.1 Features

- a) Adopt electric gutta-percha injection method, easy glue injection and uniform gutta-percha output.
- b) The two buttons are set up symmetrically, and the buttons are set at the holding position of the doctor’s thumb and index finger, making the operation more convenient.
- c) Cordless design for Hot Melting and Filling Instrument effectively broadens the operation space.
- d) Sensitive temperature control, simple display, and convenient operation; Press temperature setting button to set suitable working temperature.
- e) Five preset temperatures are for option: 100°C, 120°C, 150°C, 180°C, 200°C ; Three levels of injection speed are for option: slow speed, medium speed, high speed.
- f) Safe protecting system, with the timeout automatic shutdown function.
- g) The battery can be replaced quickly and easily.

1.4.2 Scope of applications

Only used in endodontic filling with gutta-percha or root canal sealant. Fi-E is equipped with Gutta-Percha Injecting Needle and Thermal Protector Cap to heat up and soften gutta-percha to backfill root canal.

**1.5 Product specifications**

Sizes	Hot Melting and Filling Instrument	25mm×28mm×200mm
	Charging base	90mm×115mm×56mm

Weight	Hot Melting and Filling Instrument	148g
	Charging base	179g
	Power adapter	167g

### **1.6 Technical parameters**

Classification	Class II (AC/DC power adapter)	
Optional preset temperatures	100°C→120°C→150°C→180°C→200°C	
Time consumption for charging	About 2.5h (First charging needs 3 h)	
Power supply	Input	AC100V-240V 50/60Hz 800mA
	Output	DC15V/1.6A
The model of power adapter	UE24WCPI-15V/1.6A	
Battery capacity	Chargeable battery	2000mAh
The model of the battery	18500 3.7V 2000mAh 7.4Wh P	
Heater Rating	10W	
Software version	Fi-E_V1.0.0	

### **1.7 Environmental parameters**

Working condition	Temperature	+5°C ~+40°C
	Humidity	30% ~75%
	Air pressure	70kPa ~106kPa

















### **1.8 Storage and transport**

- 1.The device should be handled carefully and lightly. Be sure that it is far from the vibration, and is installed or kept in a cool, dry, and ventilated place.
- 2.Do not store the device together with the articles that are combustible poisonous, caustic, or explosive.
- 3.The device should be stored in a room where the relative humidity is 10% ~ 93%, the air pressure is 70kPa ~ 106kPa, and the temperature is -20°C ~ +55°C.
- 4.Please avoid the device from strong shock or vibration during transport. And please handle it carefully.
- 5.Please do not mix the device with hazardous articles during transport.
- 6.Please avoid the device from sun, rain, and snow during transport.

## **2 European authorized representative**



### 3 Standard icons

	Product serial number		Follow instructions for use
	Manufacturer		Date of manufacture
	Type B applied part		Class II device
	Power switch	<b>IPX0</b>	Ordinary equipment
	Used indoor only		Caution ,hot surface
	Can be autoclaved	DC 15V	DC 15V
	Rectilinear motion	<b>CE</b> <sup>0197</sup>	CE marked product
	Device complies with WEEE directive		
	Attention! Please refer to the accompanying documents.		
	Humidity limit for storage:10%~93%		
	Atmospheric pressure for storage:70kPa~106kPa		
	Temperature limit for storage:-20°C~+55°C		
<b>EC REP</b>	Authorised Representative in the EUROPEAN COMMUNITY		

### 4 Contraindications

1. People who are allergic to known natural latex and metals such as stainless steel, silver, copper, etc. are forbidden to use this device.
2. The patient with hemophilia is forbidden to use this device.
3. The patients with heart pacemaker are forbidden to use this device.
4. The dentists with heart pacemaker are forbidden to use this device.
5. Heart disease patients, pregnant women and children should be cautious to use the equipment.

### 5 Installation and disassembly method of accessories

#### 5.1 Connection of power adapter

Connect the output point of power adapter to the charging base, and connect the input point to the socket that meets the standard of this power adapter. Please install in accordance with the procedures in Figure 2, Figure 3, and Figure 4.

#### 5.2 Installation,disassembly and pre-bent of Gutta Percha Injecting Needle

Note: In order to prevent from scalding, when replace the Gutta Percha Injecting Needle, please first power off and wait for 5 minutes. Only after the heating chamber cools down, the replacement can start.

1.Power off the device and wait for 5 minutes until the Hot Melting and Filling Instrument cools down. And then use wrench to disassemble the needle in counter-clockwise direction.

2.Place the used needle in the dedicated container.

3.Select needed Gutta Percha Injecting Needle (20Ga, 23Ga or 25Ga), tighten the new injecting needle clockwise to the Hot Melting and Filling Instrument.

4.Use wrench to bend the needle to needed angle.

### **5.3 Installation and disassembly of Thermal Protector Cap**

Start installation and disassembly from head part of the Hot Melting and Filling Instrument.

### **5.4 Removal and replacement of battery**

When removing the battery, press inward on the raised stripes at the end of the handle, and then remove the battery.

When installing the battery, align the indicator arrow on the battery with the indicator arrow at the end of the handle, then buckle the battery into the handle. Hold the end of the end of battery( do not press the raised stripes) and gently pull the battery to ensure that the battery will not come loose.

### **5.5 Removal and replacement of gutta-percha ring**

When the gutta-percha ring has a lot of residual gutta-percha that cannot be cleaned, you can use the hexagonal hole on the wrench to align the six-square of the gutta-percha ring, turn the wrench counterclockwise to remove the gutta-percha ring, then use a wrench to screw a new gutta-percha ring clockwise to the handle and screw it to the end .The operation method is shown in the figure .

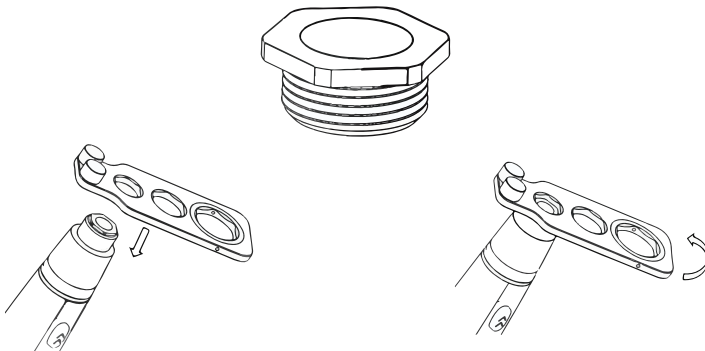

## **6 Operation method**

Note :

**1. During use, please do not contact the heating part of the Hot Melting and Filling Instrument. Before use, remember to install the Thermal Protector Cap to prevent users or patients from scalding.**

### **6.1 Choose Gutta Percha Injecting Needle**

Choose suitable Gutta Percha Injecting Needle (20ga, 23ga or 25ga) according to the situation of patient. And tighten the Gutta Percha Injecting Needle and handpiece (Note: not too tight). When using, the Gutta Percha Injecting Needle can rotate to suitable angle within the range of 360° in clockwise direction and counterclockwise direction. And you can also use wrench to pre-bend the needle and adjust it to a better operation angle as per your needs.

#### **Warning:**

- 1. When install the Injecting Needle, please be sure that the device is off and the head part of the device is cooling down. (About 5 minutes after shutdown of the Hot Melting and Filling Instrument, the head part of it can cool down to the temperature that allows people to touch.)**
- 2. The pre-bending angle of the Injecting Needle cannot exceed 90 °, and do not bend in the size transitional parts of the needle.**

### **6.2 Choose the gutta-percha**

Choose suitable gutta-percha for the device (the diameter of the gutta-percha is less than 3mm, and the length of the gutta-percha is less than 17mm). Remove the injecting needle firstly, put the gutta-percha into the hole at the end of the injecting needle, and then screw the injecting needle clockwise into the handle and tighten it.

Note:

1. only one gutta-percha stick can be placed at a time.
2. Failure to fully fit the gutta-percha into the heating chamber will result in function failure of the device.

### **6.3 Power on and Setting**

#### **6.3.1 Power on**

After powering on with long press on “ON/OFF” button, the standby interface display content is: ① The serial number of mode; ② Preset temperature; ③ Injecting speed; ④ Battery power.

#### **6.3.2 Mode setting**

The device provides three groups of customizable parameter modes, the parameters in each group of modes can be customized and saved.

After entering the normal standby interface, short press the mode button to switch modes (3 modes can be customized). Long press the mode button to enter the mode content mode setting interface of the currently mode, short press the “ON/OFF” button to adjust the parameters, short press the mode button to switch the adjustment items, short press the injecting button to save the parameters and returns to the normal standby interface.

The contents of the mode that can be adjust includes:

① Set preset temperature 100-200°C adjustable, 100°C, 120°C, 150°C, 180°C, 200°C);

② The speed of injecting (fast, medium and slow three gears adjustable);

③ Change the gutta-percha (YES/NO) option, after selecting “YES” ,short press the injecting button to start the gutta-changing procedure, short press the “ON/OFF” button to exit the gutta-changing procedure .The specific steps as folows:

1) Start heating, the display shows “Heating . . . Please wait” , wait for the temperature to rise to the preset temperature;

2) Start the gutta-percha injection, empty the remaining gutta-percha, the speed indicator shows the fast gear and flashes until the gutta is emptied.

3) Reset in the fast gear, during the process, the speed indicator on the display points to the return direction and flashes until the resetting is complete;

4) The display shows the prompt “Insert Gutta-Percha” to insert a new gutta-percha;

5) Press any button to return to the standby interface.

### 6.3.3 Function setting

In the shutdown state , long press the mode button and the “ON/OFF” button to turn on the function setting interface, short press the “ON/OFF” button to adjust the parameters ,short press the mode button to switch content, short press the injecting button to save the set parameters and exit the setting interface to enter normal start-up and standby interface. The functions that can be set are:

① Set the automatic shutdown time (5-10 minutes adjustable), the default is 5 minutes;

② Set the buzzed volume ,3 levels are available,the default is meduim volume.

## **6.4 Heating and Canal obturation**

After selecting the appropriate mode , short press the injecting button to start heating, if you need to stop heating,short press the “ON/OFF” button. The contents displayed on the heating interface in the heating state are:

① The serial number of mode; ② Preset temperature; ③ Injecting speed;

④ Battery power.The heating indicator flashes when heating starts, and when the temperature reaches the preset vaule, the heating indicator is always on.If you need to stop heating,short press the “ON/OFF” button, and the heating indicator goes out.

Install the Thermal Protector Cap at the connecting part of Gutta Percha Injecting Needle and Hot Melting and Filling Instrument, and wipe the filling material from the needle with gauze and alcohol.

Note: The needle starts filling from the bottom of the root canal to reduce

or avoid the generation of bubbles. Place the needle at the bottom of the root canal, press the injecting button to squeeze out the gutta percha, then slowly withdraw the needle tip until the coronal hole.

 **Warning:**

**The maximum temperature of the applied part surface is 97°C . After heating, the glue injection needle should not stay in the oral cavity for more than 5 seconds to prevent scalding the patient.**

## **6.5 Replacement of gutta-percha**

When the gutta-percha is finished , you will hear a “di” sound. After releasing the injecting button, the device will automatically return to initial position, wait for the screen shows “Insert Gutta-Percha”, and then you can insert a new gutta-percha.

When inserting a new gutta-percha , make sure that the front end of the Hot Melting and Filling Instrument has cooled to room temperature to prevent burns , and re-select a suitable gutta-percha to insert according to chapter 3.2.

## **6.6 Cleaning , Disinfection , Sterilization and Maintenance**

After operation, the remaining materials in the heating chamber must be cleaned, and the relevant accessories must be cleaned, disinfected and sterilized. For details, see Chapter 9.

## **7 Charging instruction**

7.1 Use corresponding charging base for charging: Connect the power adapter to the charging base, and connect to power supply. And then correctly place the Hot Melting and Filling Instrument in the charging base. When the Hot Melting and Filling Instrument is not placed on the charging base, the indicator will flashes in amber and green alternately. When the Hot Melting and Filling Instrument is placed on the charging base, if the charging is being charged, the amber indicator will be on constantly. When the battery is full, the amber indicator will be off and the green indicator will be on constantly. Under normal situation, the charging takes about 2.5h.

7.2 The battery used in this product has no memory and can be used at any time or charged at any time.

7.3 Before first use of this device, please charge it at least for 3 hours.

 **Warning:**

- 1. If the device is not in use for a long time, please unplug the adapter to isolate the circuits electrically from the supply mains.**
- 2. Do not perform medical functions during charging.**
- 3. Equipment must be connected to an appropriate power source when loss of power source would result in an unacceptable risk.**

## **8 Safety precautions**

8.1 Do not use instruments other than the provided wrench to install, disassemble or pre-bent Gutta Percha Injecting Needle.

8.2 Do not knock or scratch the Hot Melting and Filling Instrument.

8.3 Keep heat carrier accessories such as Hot Melting and Filling Instrument, Gutta Percha Injecting Needle, Thermal Protector Cap etc. under heating state away from inflammable and explosive materials.

8.4 Please keep the device clean before and after operation. Before each use, please clean, disinfect and sterilize the accessories such as Gutta Percha Injecting Needle, Thermal Protector Cap and wrench.

8.5 The product should be in strict accordance with relevant operation specifications of medical authority and relative regulations. The product can only be operated by trained doctors or technicians.

8.6 Do not install, remove, or replace the Thermal Protector Cap and needle under heating state. If you need to replace the needle, please first power off and wait for 5 minutes. Five minutes later, if the Hot Melting and Filling Instrument totally cools down, replace the needle.

8.7 The needle must be correctly installed to prevent from falling off or gutta-percha leakage during operation.

8.8 Do not use excessive force when pre-bending the injection needle to prevent the needle from breaking. When the needle is bent or worn, the gutta-percha flowing ability may be deteriorated, and the operator should replace the new needle in time according to the clinical condition.

8.9 If the device is not in use for a long time, please remove the battery.

8.10 If the device is abnormal, cannot be shut down normally, or needs an emergency stop, please unplug the battery.

8.11 Do not place the device where it is difficult to operate the disconnect device.

8.12 Woodpecker is specialized in producing medical instrument. We are only responsible for the safety on the following conditions:

a) The maintenance, repair, and modification are made by the manufacturer or the authorized dealers.

b) The charged components are original of “Woodpecker” and operated according to instruction manual.

## 9 Cleaning, Disinfection, Sterilization and Maintenance

The cleaning, disinfection and sterilization of Gutta Percha Injecting Needle. Unless otherwise stated, it will be hereinafter referred to as “product”.

 **Warnings:**

**The use of strong detergent and disinfectant (alkaline pH>9 or acid pH <5) will reduce the life span of product. And in such cases, the manufacturer takes no responsibility. This product shall not be exposed to high temperature above 138°C.**

## **9.1 Processing limit**

The Injecting Needle is a one-time use product. But follow the steps to clean, disinfect and sterilize before use.

## **9.2 Initial processing**

### 9.2.1 Processing principles

It is only possible to carry out effective sterilization after the completion of effective cleaning and disinfection. Please ensure that, as part of your responsibility for the sterility of product before use, only sufficiently validated equipment and product-specific procedures are used for cleaning/disinfection and sterilization, Please also observe the applicable legal requirements in your country as well as the hygiene regulations of the hospital or clinic, especially with regard to the additional requirements for the inactivation of prions.

### 9.2.2 Post-operative treatment

The post-operative treatment must be carried out immediately, no later than 30 minutes after the completion of the operation. The steps are as follows:

- 1.Remove the injection needle , please refer to section 5.2.
- 2.Remove the remaining Gutta Percha materials in the heating cavity . For specific operations, please refer to point 11 in section 1.2.



### **Warnings:**

**The injection needle after surgery cannot be used again.**

### 9.2.3 Preparation before cleaning

Tools: Wrench ,tray, clean and dry soft cloth. The steps are as follows:

- 1.Installing the injection needle Refer to section 5.2.
- 2.Squeeze out the Gutta Percha materials in the heating cavity and ensure that the Gutta Percha materials injected from the Gutta Percha Injecting Needle exceed 30mm.
- 3.Remove the Gutta Percha Injecting Needle from the handle with the wrench provided by guilin woodpecker medical instrument co., LTD. Then Put them into a clean tray.
- 4.Wipe and Clean the surface of Gutta Percha Injecting Needle with a clean cloth dipped in cleaning agent until no dirt can be seen on the surface. Then dry it with a soft cloth and put them into a clean tray. Cleaning agent can be pure water.

### **Notes:**

**The pure water temperature should not exceed 45 °C, otherwise the protein will solidify and it is difficult to remove.**

## **9.3 Cleaning**

The cleaning should be performed no later than 24 hours after the operation.The cleaning adopt automated cleaning.

The cleaning procedure are as follows.

- 1.Pre-wash with pure water at 25°C for 3 minutes.
- 2.Clean with the condition recommended by the cleaning agent manufacturer for 5 minutes. For example the detergent use RUHOF ENDOZIME AW PLUS WITH APA,Dilution Ratio1: 270, temperature 25°C.Clean for 5 minutes.
- 3.Rinse twice with pure water at 25°C for 1 minute each.

**Notes:**

- a) The solution used the pure water and only freshly prepared solutions can be used.
- b) During the use of cleaner, the concentration and time provided by manufacturer shall be obeyed.
- c) The cleaner is proved to be valid by CE certificationin accordance with EN ISO 15883.
- d) The cleaning procedure is suitable for the product, and the irrigating period is sufficient.

#### **9.4 Disinfection**

Disinfection must be performed no later than 2 hours after the cleaning phase.Automated disinfection is preferred if conditions permit. For the thermal disinfection here, the temperature is 93°C, the time is 5 minutes, and A0>3000.

Cleaning and disinfecting steps by using Washer-disinfector.

1.Carefully place the Gutta Percha Injecting Needle , the Gutta Percha Injecting Needle Protector ,the Thermal Protector Cap and the Wrench into the disinfection basket. Fixation of product is needed only when the product is removable in the device. The product is not allowed to contact each other.

2.Start the program.

3.After the program is finished, remove the product from the washer-disinfector, inspect (refer to section “Inspection and Maintenance”) and packaging (refer to chapter “Packaging”). Dry the product repeatedly if necessary (refer to section“Drying”).

The intrinsic suitability of the product for effective cleaning and disinfection using the above automated cleaning and disinfection procedures was verified by a certified facility.

**Notes:**

- a) Before use the washer-disinfector, you must carefully read the operating instructions provided by the equipment manufacturer to familiarize yourself with the disinfection process and precautions.
- b) With this equipment, cleaning, disinfection and drying will be carried out together.
- c) Only distilled or deionized water with a small amount of microorganisms (<10 cfu/ml) can be used for all rinsing steps.



(For example, pure water that is in accordance with the European Pharmacopoeia or the United States Pharmacopoeia).

d) The air used for drying must be filtered by HEPA.

e) Regularly repair and inspect the disinfectant.

## **9.5 Drying**

If your cleaning and disinfection process does not have an automatic drying function, dry it after cleaning and disinfection.

Methods

1. Spread a clean white paper (white cloth) on the flat table, point the product against the white paper (white cloth), and then dry the product with filtered dry compressed air (maximum pressure 3 bar). Until no liquid is sprayed onto the white paper (white cloth), the product drying is completed.

2. It can also be dried directly in a medical drying cabinet (or oven). The recommended drying temperature is 80°C~120°C and the time should be 15~40 minutes.

**Notes:**

a) The drying of product must be performed in a clean place.

b) The drying temperature should not exceed 138°C;

c) The equipment used should be inspected and maintained regularly.

## **9.6 Inspection and maintenance**

In this chapter, we only check the appearance of the product. After inspection, ensure that there is no problem.

1. Check the product. If there is still visible stain on the product after cleaning/ disinfection, the entire cleaning/disinfection process must be repeated.

2. Check the product. If it is obviously damaged, smashed, detached, corroded, it must be scrapped and not allowed to continue to be used.

3. Check the product. If the accessory is found to be damaged, please replace it before use. And the new accessory for replacement must be cleaned, disinfected and dried.

4. If the number of times of the product reaches the specified number of times, please replace it in time.

## **9.7 Packaging**

Install the disinfected and dried product and quickly package it in a medical sterilization bag (or special holder, sterile box).

1. The package used conforms to ISO 11607;

2. It can withstand high temperature of 138°C and has sufficient steam permeability;

3. The packaging environment and related tools must be cleaned regularly to ensure cleanliness and prevent the introduction of contaminants;

4. Avoid contact with parts of different metals when packaging.

## **9.8 Sterilization**

Use only the following steam sterilization procedures (fractional pre-vacuum procedure\*) for sterilization, and other sterilization procedures are not recommended:

- 1.The steam sterilizer complies with EN13060 or is certified according to EN 285 to comply with EN ISO 17665;
- 2.The sterilization time is 5 minutes at a temperature of 134°C and a pressure of 2.0 bar ~ 2.3 bars.

Verification of the fundamental suitability of the products for effective steam sterilization was provided by a verified testing laboratory.

### **Notes:**

- a) Only the product that have been effectively cleaned and disinfected are allowed to be sterilized;
- b) Before using the sterilizer for sterilization, read the Instruction Manual provided by the equipment manufacturer and follow the instructions.
- c) Do not use hot air sterilization and radiation sterilization as this may result in damage to the product;
- d) Please use the recommended sterilization procedures for sterilization. It is not recommended to sterilize with other sterilization procedures such as ethylene oxide, formaldehyde and low temperature plasma sterilization. The manufacturer assumes no responsibility for the procedures that have not been recommended. If you use the sterilization procedures that have not been recommended, please adhere to related effective standards and verify the suitability and effectiveness.
- e) \* Fractional pre-vacuum procedure = steam sterilization with repetitive pre--vacuum. The procedure used here is to perform steam sterilization through three pre-vacuums.

## **9.9 Storage**

- 1.Store in a clean, dry, ventilated, non-corrosive atmosphere with a relative humidity of 10% to 93%, an atmospheric pressure of 70KPa to 106KPa, and a temperature of -20 °C to +55 °C;
- 2.After sterilization, the product should be packaged in a medical sterilization bag or a clean sealing container, and stored in a special storage cabinet. The storage time should not exceed 7 days. If it is exceeded, it should be reprocessed before use.

### **Notes:**

- a) The storage environment should be clean and must be disinfected regularly;
- b) Product storage must be batched and marked and recorded.

## **9.10 Transportation**

- 1.Prevent excessive shock and vibration during transportation, and handle with care;

- 2.It should not be mixed with dangerous goods during transportation.
- 3.Avoid exposure to sun or rain or snow during transportation.

**9.11 The cleaning and disinfection of Hot Melting and Filling Instrument and charging base .**

- 1.Before each use, wipe the surface of the Hot Melting and Filling and charging base with a soft cloth or paper towel soaked in 75% medical alcohol. Repeat the wipe for at least 3 times.
- 2.After each use, wipe the surface of the main engine and charging base with a clean soft cloth soaked in pure water or a clean disposable wet paper towel, and repeat for at least 3 times.

**9.12 Daily maintenance**

When the device is not used, please turn off the power and unplug the power supply plug.

If the Hot Melting and Filling Instrument is in a low battery state for a long time, the service life of battery will be shortened. Please charge it in time if the battery level is low. When the device is not used, please charge t for 1 hour once a month.

 **Warning:**

**Equipment and all accessories shall not be maintained during use.**

**9.13 Repair of device**

This product does not contain self-repairing spare parts. If there is any abnormality in the equipment, please contact our company for maintenance and do not disassemble without authorization. With our company's consent, we will provide circuit diagrams, component part lists, descriptions, calibration instructions to assist to SERVICE PERSONNEL in parts repair.

**10 Troubleshooting**

Fault	Cause	Solution
<p>After pressing the “ON/OFF” button, the device is still off.</p>	<ol style="list-style-type: none"> <li>1. Inadequate battery power</li> <li>2. Battery is damaged.</li> <li>3. The charging interface is short-circuited, causing the lithium battery to enter a protection state;</li> <li>4. Hot Melting and Filling Instrument is damaged.</li> </ol>	<ol style="list-style-type: none"> <li>1. Connect to power supply to charge. / Replace the battery.</li> <li>2. Replace the battery.</li> <li>3. Remove the substance that causes the short circuit, put the device into the charging base to charge, and then the device will return to normal.</li> <li>4. Contact local distributor or manufacturer.</li> </ol>

Gutta-percha cannot flow out from the needle	<ol style="list-style-type: none"> <li>1. The push ram has been pushed to the end, indicating that the gutta-percha has run out.</li> <li>2. The pushing ram seal ring is damaged.</li> <li>3. The needle is damaged and blocked.</li> </ol>	<ol style="list-style-type: none"> <li>1. Pull back the pushing ram and load a new gutta-percha stick.</li> <li>2. Replace the pushing ram.</li> <li>3. Replace the needle.</li> </ol>
Automatic shutdown	If there is no operation for 5 minutes, the device will automatic powers off	Reboot
The Gutta Percha Injecting Needle cannot be taken out.	The injecting needle and the pushing ram are cemented by the cooling of the gutta-percha.	<ol style="list-style-type: none"> <li>1. Power on and set the temperature to 150 °C. After the temperature reaches the set value, use the wrench to turn counterclockwise to take out the Gutta Percha Injecting Needle .</li> <li>2. Contact your local dealer or our company.</li> </ol>
Charging failure after connecting to power supply.	<ol style="list-style-type: none"> <li>1. The power supply is not correctly connected.</li> <li>2. The power supply is damaged, or the specification doesn't match.</li> <li>3. There are impurities on the contact thimble of charging base.</li> </ol>	<ol style="list-style-type: none"> <li>1. Unplug and reconnect.</li> <li>2. Replace the battery.</li> <li>3. Wipe the thimble with alcohol under the premise of power failure.</li> </ol>
The service time after each charging is shortened.	The battery capacity becomes smaller.	Send to the repair center.

## 11 After-sales service

Since the date of sales, if the device cannot work normally for quality problem, our company will be responsible for the repair of device during the warranty period. Please refer to the Warranty Card for warranty period and warranty scope.

## 12 Environment protection

The device does not contain any harmful ingredients. It can be handled or destroyed in accordance with the relevant local regulations.

Note:

1) Without Woodpecker agreement and authorization, private modification of device may result in the electromagnetic compatibility problem of that

device or other devices.

2) The design and test of Hot Melting and Filling Instrument complies with the related operation regulations of electromagnetic compatibility.

### 13 EMC-Declaration of conformity

The device has been tested and homologated in accordance with EN 60601-1-2 for EMC. This does not guarantee in any way that this device will not be effected by electromagnetic interference avoid using the device in high electromagnetic environment.

#### Technical Description Concerning Electromagnetic Emission

**Table 1: Declaration - electromagnetic emissions**

<b>Guidance and manufacturer’s declaration - electromagnetic emissions</b>		
The model Fi-E is intended for use in the electromagnetic environment specified below. The customer or the user of the model Fi-E should assure that it is used in such an environment.		
<b>Emissions test</b>	<b>Compliance</b>	<b>Electromagnetic environment - guidance</b>
RF emissions CISPR 11	Group 1	The model Fi-E uses RF energy only for its internal function. Therefore, its RF emissions are very low and are not likely to cause any interference in nearby electronic equipment.
RF emissions CISPR11	Class B	The model Fi-E is suitable for used in all establishments, including domestic establishments and those directly connected to the public low-voltage power supply network that supplies buildings used for domestic purposes.
Harmonic emissions IEC 61000-3-2	Class A	
Voltage fluctuations / flicker emissions IEC 61000-3-3	Complies	

#### Technical Description Concerning Electromagnetic Immunity

**Table 2: Guidance & Declaration - electromagnetic immunity**

<b>Guidance &amp; Declaration — electromagnetic immunity</b>			
The model Fi-E is intended for use in the electromagnetic environment specified below. The customer or the user of the model Fi-E should assure that It is used in such an environment.			
<b>Immunity test</b>	<b>IEC 60601 test level</b>	<b>Compliance level</b>	<b>Electromagnetic environment - guidance</b>
Electrostatic discharge (ESD) IEC 61000-4-2	±8kV contact ±2, ±4, ±8, ±15kV air	±8kV contact ±2, ±4, ±8, ±15kV air	Floors should be wood, concrete or ceramic tile. If floors are covered with synthetic material, the relative humidity should be at least 30 %.

Electrical fast transient/burst IEC 61000-4-4	±2kV for power supply lines ±1kV for Input/output lines	±2kV for power supply lines	Mains power quality should be that of a typical commercial or hospital environment.
Surge IEC 61000-4-5	±0.5, ±1kV line to line ±0.5, ±1, ±2kV line to earth	±0.5, ±1kV line to line ±0.5, ±1, ±2kV line to earth	Mains power quality should be that of a typical commercial or hospital environment.
Voltage dips, short interruptions and voltage variations on power supply input lines IEC 61000-4-11	<5 % UT (>95% dip in UT.) for 0.5 cycle <5 % UT (>95% dip in UT.) for 1 cycle 70% UT (30% dip in UT) for 25 cycles <5% UT (>95 % dip in UT) for 250 cycles	<5 % UT (>95% dip in UT.) for 0.5 cycle <5 % UT (>95% dip in UT.) for 1 cycle 70% UT (30% dip in UT) for 25 cycles <5% UT (>95 % dip in UT) for 250 cycles	Mains power quality should be that of a typical commercial or hospital environment. If the user of the models Fi-E requires continued operation during power mains interruptions, it is recommended that the models Fi-E be powered from an uninterruptible power supply or a battery.
Power frequency (50/60 Hz) magnetic field IEC 61000-4-8	30A/m	30A/m	Power frequency magnetic fields should be at levels characteristic of a typical location in a typical commercial or hospital environment.
NOTE UT is the a.c. mains voltage prior to application of the test level.			

**Table 3: Guidance & Declaration - electromagnetic immunity concerning Conducted RF & Radiated RF**

<b>Guidance &amp; Declaration - Electromagnetic immunity</b>			
The model Fi-E is intended for use in the electromagnetic environment specified below. The customer or the user of the models Fi-E should assure that it is used in such an environment.			
<b>Immunity test</b>	<b>IEC 60601 test level</b>	<b>Compliance level</b>	<b>Electromagnetic environment - guidance</b>

<p>Conducted RF IEC 61000-4-6</p> <p>Conducted RF IEC 61000-4-6</p> <p>Radiated RF IEC 61000-4-3</p>	<p>3 Vrms 150 kHz to 80 MHz</p> <p>6 Vrms ISM frequency band</p> <p>3 V/m 80 MHz to 2.7 GHz</p>	<p>3V 6V 3V/m</p>	<p>Portable and mobile RF communications equipment should be used no closer to any part of the models Fi-E, including cables, than the recommended separation distance calculated from the equation applicable to the frequency of the transmitter.</p> <p>Recommended separation distance  <math>d=1.2 \times P^{1/2}</math>  <math>d=2 \times P^{1/2}</math>  <math>d=1.2 \times P^{1/2}</math> 80 MHz to 800 MHz  <math>d=2.3 \times P^{1/2}</math> 800 MHz to 2.7 GHz  where P is the maximum output power rating of the transmitter  In watts (W) according to the transmitter manufacturer and d is the recommended separation distance in meters (m).</p> <p>Field strengths from fixed RF transmitters, as determined by an electromagnetic site survey, a should be less than the compliance level in each frequency range. b</p> <p>Interference may occur In the vicinity of equipment marked with the following symbol:</p> 
--	---	---------------------------	---

NOTE 1 At 80 MHz end 800 MHz. the higher frequency range applies.  
NOTE 2 These guidelines may not apply in all situations. Electromagnetic propagation is affected by absorption and reflection from structures, objects and people.

a Field strengths from fixed transmitters, such as base stations for radio (cellular/ cordless) telephones and land mobile radios, amateur radio, AM and FM radio broadcast and TV broadcast cannot be predicted theoretically with accuracy. To assess the electromagnetic environment due to fixed RF transmitters, an electromagnetic site survey should be considered. If the measured field strength in the location in which the model Fi-E is used exceeds the applicable RF compliance level above, the model Fi-E should be observed to verify normal operation. If abnormal performance is observed, additional measures may be necessary, such as reorienting or relocating the model Fi-E

b Over the frequency range 150 kHz to 80 MHz, field strengths should be less than 3V/m.

**Table 4: Recommended separation distances between portable and mobile RF communications equipment and the model Fi-E**

### Recommended separation distances between

#### portable and mobile RF communications equipment and the model Fi-E

The model Fi-E is intended for use in electromagnetic environment in which radiated RF disturbances is controlled. The customer or the user of the model Fi-E can help prevent electromagnetic interference by maintaining a minimum distance between portable and mobile RF communications equipment (transmitters) and the model Fi-E as recommended below, according to the maximum output power of the communications equipment.

Rated maximum output power of transmitter W	Separation distance according to frequency of transmitter m		
	150kHz to 80MHz $d=1.2 \times P^{1/2}$	80MHz to 800MHz $d=1.2 \times P^{1/2}$	800MHz to 2,7GHz $d=2.3 \times P^{1/2}$
0,01	0.12	0.12	0.23
0,1	0.38	0.38	0.73
1	1.2	1.2	2.3
10	3.8	3.8	7.3
100	12	12	23

For transmitters rated at a maximum output power not listed above, the recommended separation distance  $d$  in meters (m) can be estimated using the equation applicable to the frequency of the transmitter, where  $P$  is the maximum output power rating of the transmitter in watts (W) accordable to the transmitter manufacturer.

NOTE 1 At 80 MHz and 800 MHz. the separation distance for the higher frequency range applies.

NOTE 2 These guidelines may not apply in all situations. Electromagnetic propagation is affected by absorption and reflection from structures, objects and people.

## 14 Statement

Woodpecker reserves the right to change the design of the equipment, the technique, fittings, instruction manual and the content of the original packing list at any time without further notice. The pictures are only for reference. The final interpretation rights belong to Guilin Woodpecker Medical Instrument Co., Ltd.



Scan and Login website  
for more information



Guilin Woodpecker Medical Instrument Co., Ltd.  
Information Industrial Park, Guilin National High-Tech  
Zone, Guilin, Guangxi, 541004 P. R. China

Sales Dept.: +86-773-5873196

[Http://www.glwoodpecker.com](http://www.glwoodpecker.com)

E-mail: [woodpecker@glwoodpecker.com](mailto:woodpecker@glwoodpecker.com)



MedNet EC-Rep GmbH  
Borkstrasse 10 · 48163 Muenster · Germany

ZMN-SM-453

V1. 0-20220224